



UFR8030C

FAST RECOVERY EPITAXIAL DIODE

ULTRAFAST SOFT RECOVERY RECTIFIER DIODE

DESCRIPTION

The UTC **UFR8030C** utilizes advanced processing techniques to achieve ultrafast recovery times and higher forward current. Its soft recovery characteristics and high reliability suit for wide industrial applications.

FEATURES

- * Ultrafast Recovery Time
- * Soft Recovery Characteristics
- * Low Recovery Loss
- * Low Forward Voltage
- * High Surge Current Capability
- * Low Leakage Current

SYMBOL

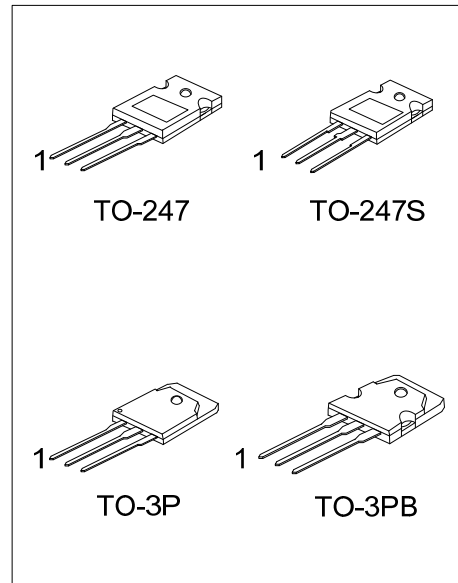
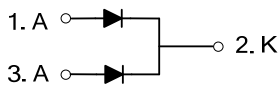

ORDERING INFORMATION

Ordering Number		Package	Pin Assignment			Packing
Lead Free	Halogen Free		1	2	3	
UFR8030CL-T3B-T	UFR8030CG-T3B-T	TO-3PB	A	K	A	Tube
UFR8030CL-T3P-T	UFR8030CG-T3P-T	TO-3P	A	K	A	Tube
UFR8030CL-T47-T	UFR8030CG-T47-T	TO-247	A	K	A	Tube
UFR8030CL-T47S-T	UFR8030CG-T47S-T	TO-247S	A	K	A	Tube

Note: Pin Assignment: A: Anode K: Cathode

<p>UFR8030CG-T3B-T</p>	<p>(1) T: Tube (2) T3B: TO-3PB, T3P: TO-3P, T47: TO-247 T47S: TO-247S (3) G: Halogen Free and Lead Free, L: Lead Free</p>
------------------------	---

MARKING

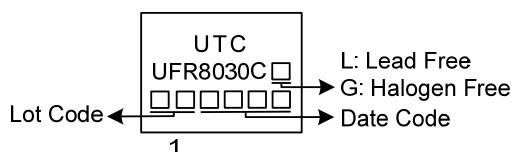

■ ABSOLUTE MAXIMUM RATINGS ($T_C=25^\circ\text{C}$ unless otherwise specified)

PARAMETER	SYMBOL	RATINGS	UNIT
Maximum D.C. Reverse Voltage	V_R	300	V
Maximum Peak Repetitive Reverse Voltage	V_{RRM}	300	V
Maximum Working Peak Reverse Voltage	V_{RWM}	300	V
Maximum Average Forward Current ($T_C=110^\circ\text{C}$)	Per Leg	40	A
	Total	80	A
Non-Repetitive Forward Surge Current ($T_J=45^\circ\text{C}$, $t=10\text{ms}$, 50Hz, Sine)	I_{FSM}	180	A
Operating Temperature Range	T_J	-40 ~ +150	$^\circ\text{C}$
Storage Temperature Range	T_{STG}	-40 ~ +150	$^\circ\text{C}$

Note: Absolute maximum ratings are those values beyond which the device could be permanently damaged. Absolute maximum ratings are stress ratings only and functional device operation is not implied.

■ THERMAL CHARACTERISTICS (PER LEG)

PARAMETER	SYMBOL	RATINGS	UNIT
Typical Thermal Resistance	θ_{JC}	0.8	$^\circ\text{C/W}$

■ STATIC ELECTRICAL CHARACTERISTICS

PARAMETER	SYMBOL	TEST CONDITIONS	MIN	TYP	MAX	UNIT
Forward Voltage	V_F	$I_F=80\text{A}$			1.3	V
		$I_F=80\text{A}$, $T_J=125^\circ\text{C}$			1.2	V
Maximum Reverse Leakage Current	I_{RM}	$V_R=300\text{V}$			1	μA
		$V_R=300\text{V}$, $T_J=125^\circ\text{C}$			100	μA

■ DYNAMIC CHARACTERISTICS

PARAMETER	SYMBOL	TEST CONDITIONS	MIN	TYP	MAX	UNIT
Reverse Recovery Time	t_{rr}	$I_F=1\text{A}$, $di_F/dt=-200\text{A}/\mu\text{s}$, $V_R=200\text{V}$		30		ns
Reverse Recovery Time	t_{rr}	$I_F=30\text{A}$, $di_F/dt=-100\text{A}/\mu\text{s}$, $V_R=200\text{V}$		52		ns

■ TEST CIRCUITS AND WAVEFORMS

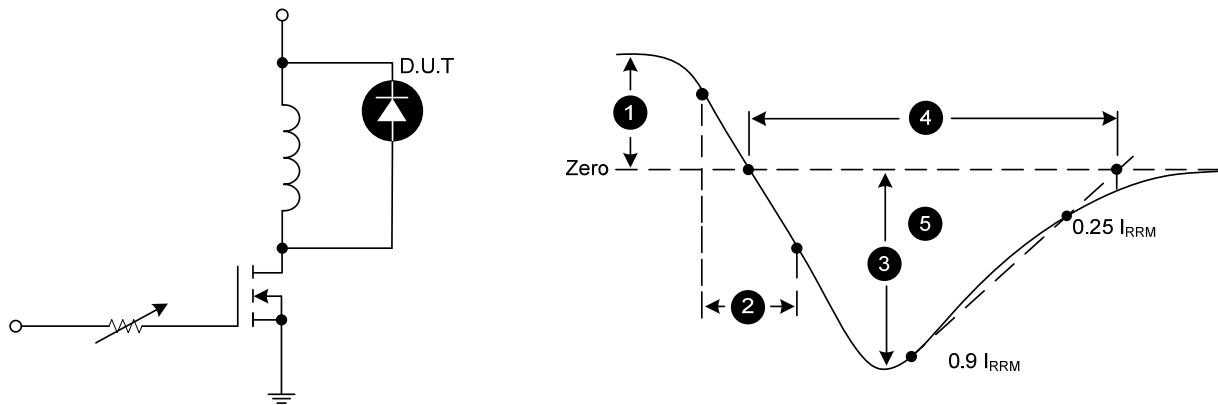

Diode Reverse Recovery Test Circuit and Waveform

1. I_F - Forward Conduction Current
2. di_F/dt - Rate of Diode Current Change Through Zero Crossing.
3. I_{RRM} - Maximum Reverse Recovery Current.
4. t_{rr} - Reverse Recovery Time, measured from zero crossing where diode current goes from positive to negative, to the point at which the straight line through I_{RRM} and $0.25 \cdot I_{RRM}$ passes through zero.
5. Q_{rr} - Area Under the Curve Defined by I_{RRM} and t_{rr} .

■ TYPICAL CHARACTERISTICS

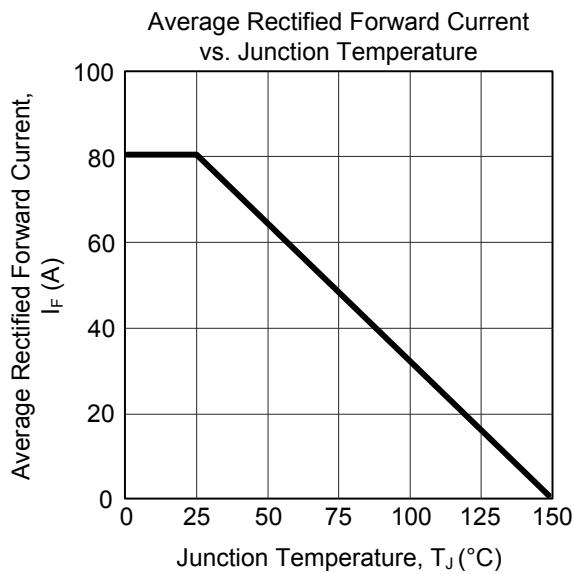
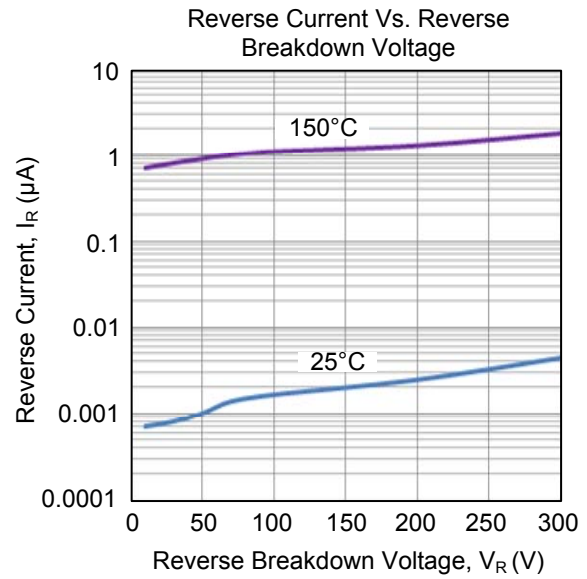
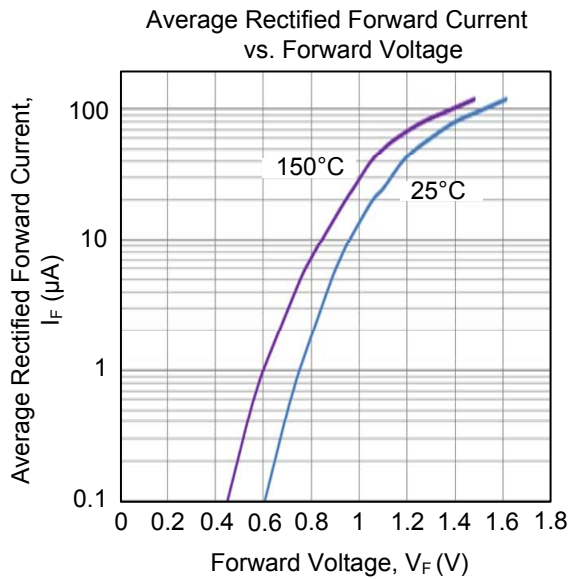

UTC assumes no responsibility for equipment failures that result from using products at values that exceed, even momentarily, rated values (such as maximum ratings, operating condition ranges, or other parameters) listed in products specifications of any and all UTC products described or contained herein. UTC products are not designed for use in life support appliances, devices or systems where malfunction of these products can be reasonably expected to result in personal injury. Reproduction in whole or in part is prohibited without the prior written consent of the copyright owner. UTC reserves the right to make changes to information published in this document, including without limitation specifications and product descriptions, at any time and without notice. This document supersedes and replaces all information supplied prior to the publication hereof.