



MJE13003-P

NPN SILICON TRANSISTOR

NPN SILICON POWER TRANSISTOR

DESCRIPTION

These devices are designed for high-voltage and high-speed power switching inductive circuits where fall time is critical. They are particularly suited for 115 and 220V applications in switch mode.

FEATURES

- * Reverse biased SOA with inductive load @ Tc=100°C
- * Inductive switching matrix 0.5 ~ 1.5 Amp, 25 and 100°C
Typical tc = 290ns @ 1A, 100°C.
- * 700V blocking capability

APPLICATIONS

- * Switching regulator's, inverters
- * Motor controls
- * Solenoid/relay drivers
- * Deflection circuits

ORDERING INFORMATION

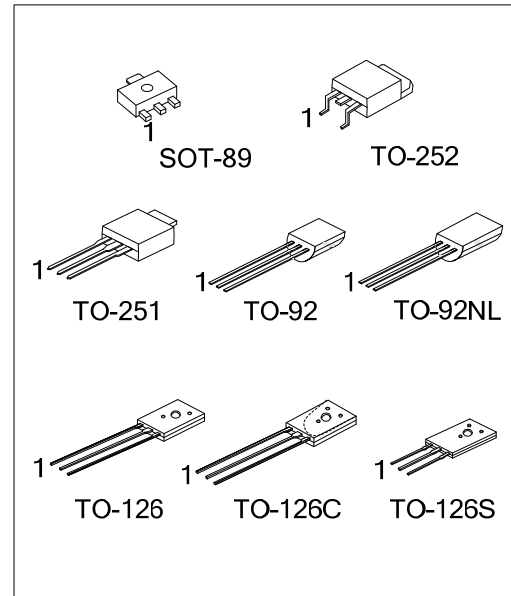

Ordering Number		Package	Pin Assignment			Packing
Lead Free	Halogen-Free		1	2	3	
MJE13003L-P-AB3-R	MJE13003G-P-AB3-R	SOT-89	B	C	E	Tape Reel
MJE13003L-P-T60-K	MJE13003G-P-T60-K	TO-126	B	C	E	Bulk
MJE13003L-P-T6C-A-K	MJE13003G-P-T6C-A-K	TO-126C	E	C	B	Bulk
MJE13003L-P-T6C-F-K	MJE13003G-P-T6C-F-K	TO-126C	B	C	E	Bulk
MJE13003L-P-T6S-K	MJE13003G-P-T6S-K	TO-126S	B	C	E	Bulk
MJE13003L-P-T92-B	MJE13003G-P-T92-B	TO-92	E	C	B	Tape Box
MJE13003L-P-T92-K	MJE13003G-P-T92-K	TO-92	E	C	B	Bulk
MJE13003L-P-T92-R	MJE13003G-P-T92-R	TO-92	E	C	B	Tape Reel
MJE13003L-P-T9N -B	MJE13003G-P-T9N-B	TO-92NL	E	C	B	Tape Box
MJE13003L-P-T9N -K	MJE13003G-P-T9N-K	TO-92NL	E	C	B	Bulk
MJE13003L-P-T9N -R	MJE13003G-P-T9N-R	TO-92NL	E	C	B	Tape Reel
MJE13003L-P-TM3-T	MJE13003G-P-TM3-T	TO-251	B	C	E	Tube
MJE13003L-P-TN3-R	MJE13003G-P-TN3-R	TO-252	B	C	E	Tape Reel

Note: Pin assignment: B: Base C: Collector E: Emitter

<p>MJE13003G-P-T6C-A-K</p>	<p>(1) R: Tape Reel, K: Bulk, B: Tape Box, T: Tube (2) refer to Pin Assignment (for TO-126C) (3) T60: TO-126, T6C: TO-126C, T6S: TO-126S T92: TO-92, T9N: TO-92NL, TM3: TO-251, TN3: TO-252 (4) G: Halogen Free and Lead Free, L: Lead Free</p>
----------------------------	--

MJE13003-P

NPN SILICON TRANSISTOR

MARKING

Package	MARKING
SOT-89	
TO-220 TO-251 TO-251S TO-252	
TO-126 TO-126C TO-126S	
TO-92	
TO-92NL	

■ ABSOLUTE MAXIMUM RATINGS

PARAMETER		SYMBOL	RATINGS	UNIT	
Collector-Emitter Voltage		$V_{CEO(SUS)}$	400	V	
Collector-Emitter Voltage ($V_{BE}=0$)		V_{CES}	700	V	
Collector-Base Voltage		V_{CBO}	700	V	
Emitter Base Voltage		V_{EBO}	9	V	
Collector Current	Continuous	I_C	1.5	A	
	Peak (1)	I_{CM}	3		
Base Current	Continuous	I_B	0.75	A	
	Peak (1)	I_{BM}	1.5		
Emitter Current	Continuous	I_E	2.25	A	
	Peak (1)	I_{EM}	4.5		
Total Power Dissipation	$T_A=25^\circ\text{C}$	SOT-89	P_D	0.5	W
		TO-126/TO-126C		1.4	W
		TO-126S		1.1	W
		TO-92/TO-92NL		1.56	W
	TO-251/TO-252	1.64		W	
	$T_C=25^\circ\text{C}$	SOT-89		20	W
		TO-126/TO-126C		1.5	W
		TO-126S		25	W
TO-92/TO-92NL					
Junction Temperature		T_J	+150	$^\circ\text{C}$	
Storage Temperature		T_{STG}	-55 ~ +150	$^\circ\text{C}$	

Note: Absolute maximum ratings are those values beyond which the device could be permanently damaged.
 Absolute maximum ratings are stress ratings only and functional device operation is not implied.

■ ELECTRICAL CHARACTERISTICS (T_C=25°C, unless otherwise specified.)

PARAMETER	SYMBOL	TEST CONDITIONS	MIN	TYP	MAX	UNIT
OFF CHARACTERISTICS (Note)						
Collector-Emitter Sustaining Voltage	V _{CEQ(SUS)}	I _C =10 mA, I _B =0	400			V
Collector Cutoff Current	I _{CEO}	V _{CEO} =Rated Value, V _{BE(OFF)} =1.5 V			1	mA
					5	mA
Emitter Cutoff Current	I _{EBO}	V _{EB} =9 V, I _C =0			1	mA
SECOND BREAKDOWN						
Second Breakdown Collector Current with base forward biased	I _{s/b}			See Fig.5		
Clamped Inductive SOA with base reverse biased	R _{B(SOA)}			See Fig.6		
ON CHARACTERISTICS (Note)						
DC Current Gain	h _{FE1}	I _C =0.4A, V _{CE} =5V	10		30	
	h _{FE2}	I _C =1A, V _{CE} =5V	5		30	
Collector-Emitter Saturation Voltage	V _{CE(SAT)}	I _C =0.5A, I _B =0.1A			0.5	V
		I _C =1A, I _B =0.25A			1	V
		I _C =1.2A, I _B =0.4A			3	V
		I _C =1A, I _B =0.25A, T _C =100°C			1	V
Base-Emitter Saturation Voltage	V _{BE(SAT)}	I _C =0.5A, I _B =0.1A			1	V
		I _C =1A, I _B =0.25A			1.2	V
		I _C =1A, I _B =0.25A, T _C =100°C			1.1	V
DYNAMIC CHARACTERISTICS						
Current-Gain-Bandwidth Product	f _T	I _C =100mA, V _{CE} =10V, f=1MHz	4	10		MHz
Output Capacitance	C _{OB}	V _{CB} =10V, I _E =0, f=0.1MHz		21		pF
SWITCHING CHARACTERISTICS						
Resistive Load (Table 1)						
Delay Time	t _D	V _{CC} =125V, I _C =1A, I _{B1} =I _{B2} =0.2A, t _p =25μs, Duty Cycle≤1%		0.05	0.1	μs
Rise Time	t _R			0.5	1	μs
Storage Time	t _S			2	4	μs
Fall Time	t _F			0.4	0.7	μs
Inductive Load, Clamped (Table 1)						
Storage Time	t _{STG}	I _C =1A, V _{clamp} =300V,		1.7	4	μs
Crossover Time	t _C	I _{B1} =0.2A,		0.29	0.75	μs
Fall Time	t _F	V _{BE(OFF)} =5Vdc, T _C =100°C		0.15		μs

Note: Pulse Test : PW=300μs, Duty Cycle≤2%.

APPLICATION INFORMATION

Table 1. Test Conditions for Dynamic Performance

Reverse Bias Safe Operating Area and Inductive Switching		Resistive Switching
Test Circuits		
Circuit Values	Coil Data : GAP for 30 mH/2 A $V_{CC}=20V$ Ferroxcube core #6656 $L_{coil}=50mH$ $V_{clamp}=300V$ Full Bobbin (~ 200 Turns) #20	$V_{CC}=125V$ $R_C=125\Omega$ $D1=1N5820$ or Equiv. $R_C=47\Omega$
Test Waveforms	<p> t_1 Adjusted to Obtain I_c $t_1 \approx \frac{L_{coil}(I_{c(pk)})}{V_{cc}}$ $t_2 \approx \frac{L_{coil}(I_{c(pk)})}{V_{clamp}}$ </p> <p>Test Equipment Scope-Tektronics 475 or Equivalent</p>	

Table 2. Typical Inductive Switching Performance

I_c (A)	T_c (°C)	t_{sv} (μs)	t_{RV} (μs)	t_{F1} (μs)	t_{T1} (μs)	t_c (μs)
0.5	25	1.3	0.23	0.30	0.35	0.30
	100	1.6	0.26	0.30	0.40	0.36
1	25	1.5	0.10	0.14	0.05	0.16
	100	1.7	0.13	0.26	0.06	0.29
1.5	25	1.8	0.07	0.10	0.05	0.16
	100	3	0.08	0.22	0.08	0.28

Note: All Data Recorded in the Inductive Switching Circuit in Table 1

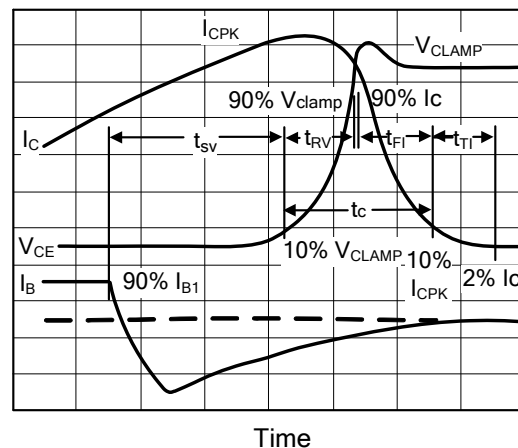

Fig.1 Inductive Switching Measurements

SWITCHING TIMES NOTE

In resistive switching circuits, rise, fall, and storage times have been defined and apply to both current and voltage waveforms since they are in phase. However, for inductive loads, which are common to switch mode power supplies and hammer drivers, current and voltage waveforms are not in phase. Therefore, separate measurements must be made on each waveform to determine the total switching time. For this reason, the following new terms have been defined.

- t_{SV} = Voltage Storage Time, 90% I_{B1} to 10% V_{clamp}
- t_{RV} = Voltage Rise Time, 10 ~ 90% V_{clamp}
- t_{FI} = Current Fall Time, 90 ~ 10% I_C
- t_{TI} = Current Tail, 10 ~ 2% I_C
- t_C = Crossover Time, 10% V_{clamp} to 10% I_C

For the designer, there is minimal switching loss during storage time and the predominant switching power losses occur during the crossover interval and can be obtained using the standard equation:

$$P_{SWT} = 1/2 V_{CC} I_C (t_C) f$$

In general, $t_{RV} + t_{FI} \approx t_C$. However, at lower test currents this relationship may not be valid.

As is common with most switching transistors, resistive switching is specified at 25°C and has become a benchmark for designers. However, for designers of high frequency converter circuits, the user oriented specifications which make this transistor are the inductive switching speeds (t_C and t_{SV}) which are guaranteed at 100°C.

RESISTIVE SWITCHING PERFORMANCE

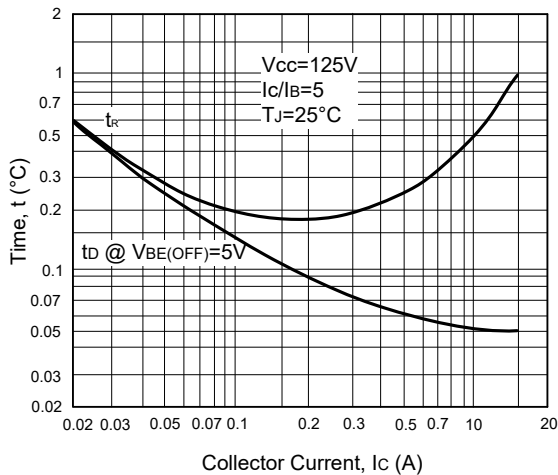

Fig.2 Turn-On Time

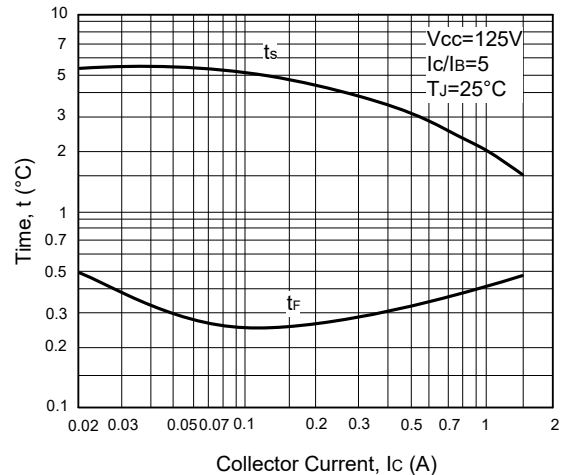

Fig.3 Turn-Off Time

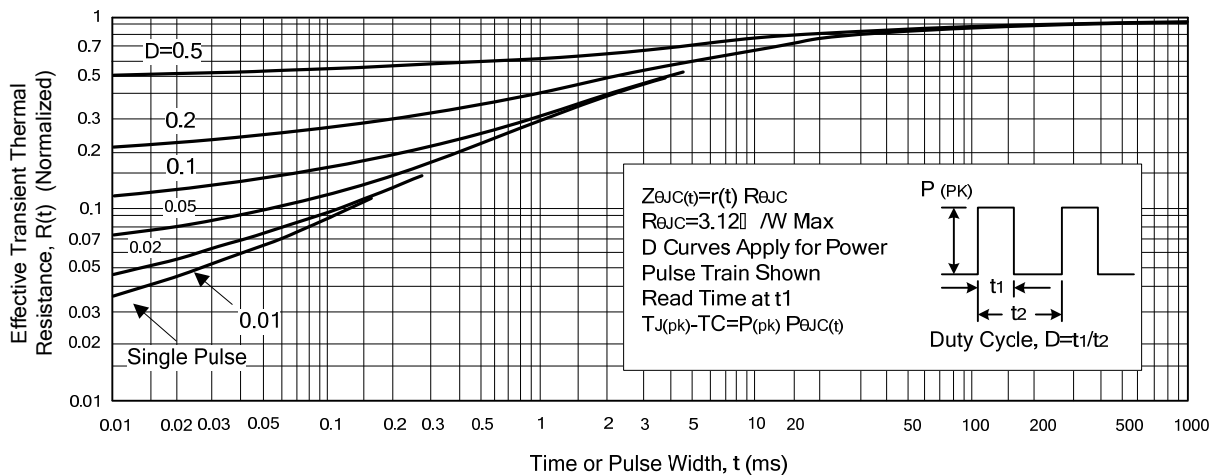

Fig.4 Thermal Response

SAFE OPERATING AREA INFORMATION

FORWARD BIAS

There are two limitations on the power handling ability of a transistor: average junction temperature and second breakdown. Safe operating area curves indicate I_C - V_{CE} limits of the transistor that must be observed for reliable operation; i.e., the transistor must not be subjected to greater dissipation than the curves indicate.

The data of Fig.5 is based on $T_C = 25^\circ\text{C}$; $T_{J(PK)}$ is variable depending on power level. Second breakdown pulse limits are valid for duty cycles to 10% but must be derated when $T_C \geq 25^\circ\text{C}$. Second breakdown limitations do not derate the same as thermal limitations. Allowable current at the voltages shown on Fig.5.

$T_{J(PK)}$ may be calculated from the data in Fig.4. At high case temperatures, thermal limitations will reduce the power that can be handled to values less than the limitations imposed by second breakdown.

REVERSE BIAS

For inductive loads, high voltage and high current must be sustained simultaneously during turn-off, in most cases, with the base to emitter junction reverse biased. Under these conditions the collector voltage must be held to a safe level at or below a specific value of collector current. This can be accomplished by several means such as active clamping, RC snubbing, load line shaping, etc. The safe level for these devices is specified as RB_{SOA} (Reverse Bias Safe Operating Area) and represents the voltage-current conditions during reverse biased turn-off. This rating is verified under clamped conditions so that the device is never subjected to an avalanche mode. Fig.6 gives RB_{SOA} characteristics.

The Safe Operating Area of Fig.5 and 6 are specified ratings (for these devices under the test conditions shown.)

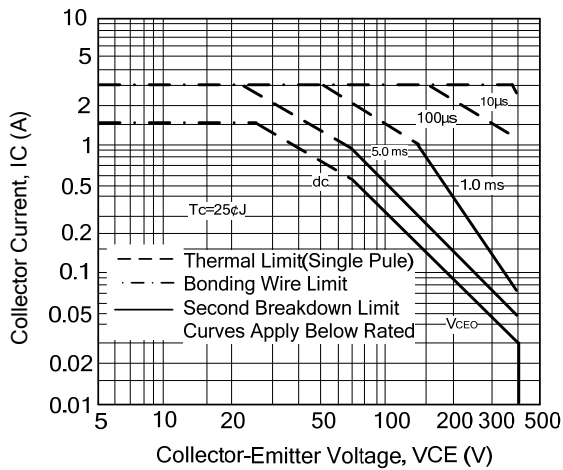

Fig.5 Active Region Safe Operating Area

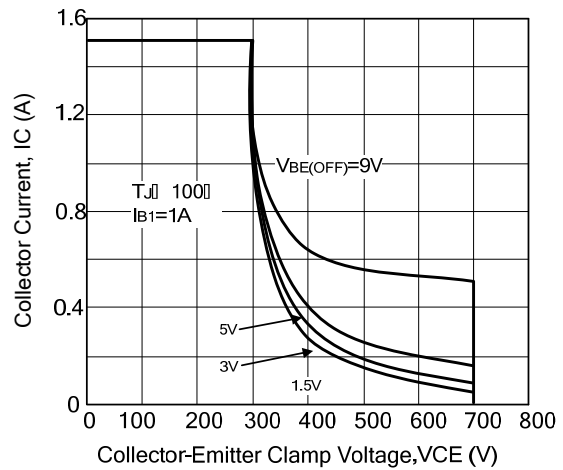
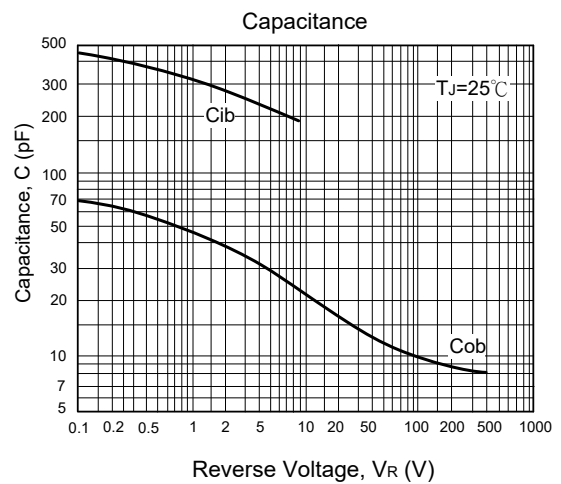
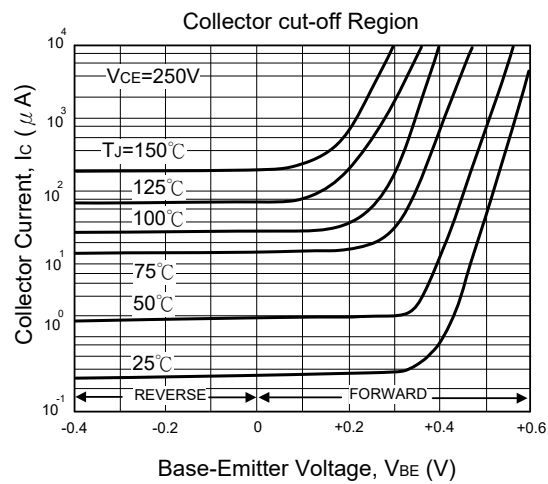
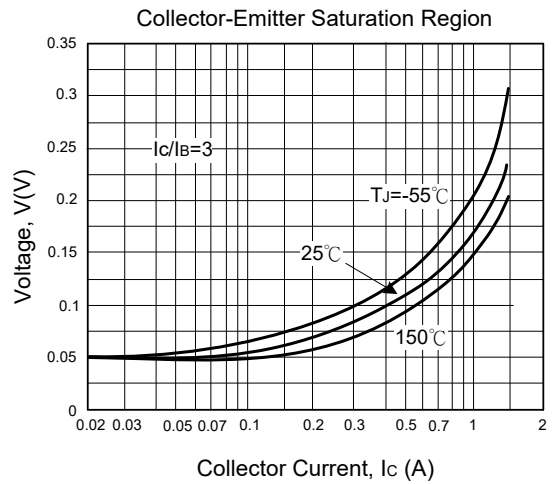
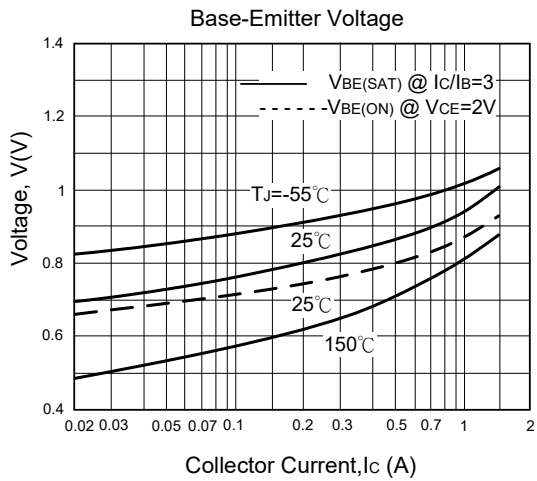
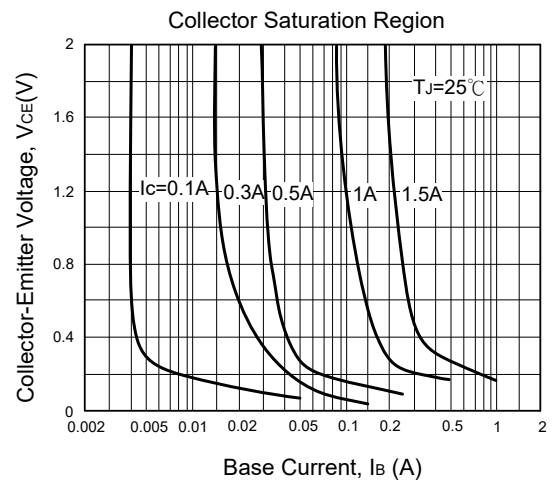
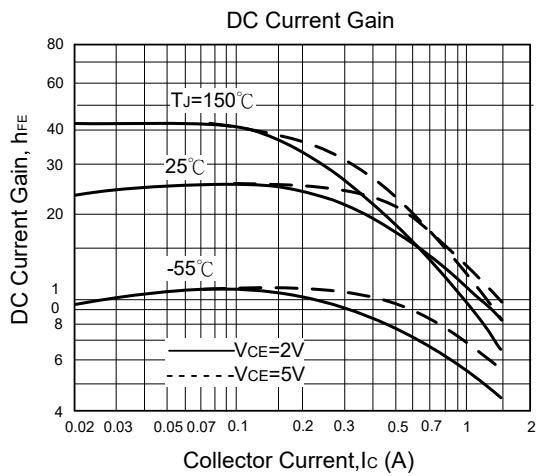
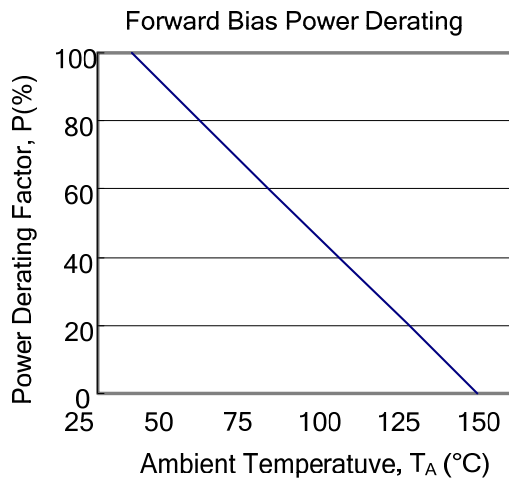

Fig.6 Reverse Bias Safe Operating Area

TYPICAL CHARACTERISTICS



■ TYPICAL CHARACTERISTICS(Cont.)



UTC assumes no responsibility for equipment failures that result from using products at values that exceed, even momentarily, rated values (such as maximum ratings, operating condition ranges, or other parameters) listed in products specifications of any and all UTC products described or contained herein. UTC products are not designed for use in life support appliances, devices or systems where malfunction of these products can be reasonably expected to result in personal injury. Reproduction in whole or in part is prohibited without the prior written consent of the copyright owner. UTC reserves the right to make changes to information published in this document, including without limitation specifications and product descriptions, at any time and without notice. This document supersedes and replaces all information supplied prior to the publication hereof.